



S2AF THRU S2MF

SURFACE MOUNT GENERAL RECTIFIER

Reverse Voltage - 50 to 1000 Volts Forward Current - 2.0 Amperes

SMAF

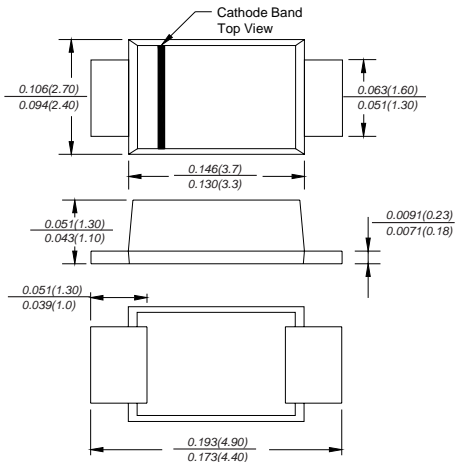

FEATURES

- ◆ The plastic package carries Underwriters Laboratory Flammability Classification 94V-0
- ◆ For surface mounted applications
- ◆ Low reverse leakage
- ◆ Built-in strain relief, ideal for automated placement
- ◆ High forward surge current capability
- ◆ High temperature soldering guaranteed: 260°C/10 seconds at terminals
- ◆ Glass passivated chip junction

MECHANICAL DATA

Case: JEDEC SMAF molded plastic body over passivated chip
Terminals: Solder plated, solderable per MIL-STD-750, Method 2026

Polarity: Color band denotes cathode end

Mounting Position: Any

Weight: 0.0018 ounce, 0.064 grams

MAXIMUM RATINGS AND ELECTRICAL CHARACTERISTICS

Ratings at 25°C ambient temperature unless otherwise specified.
 Single phase half-wave 60Hz, resistive or inductive load, for capacitive load current derate by 20%.

MDD Catalog Number	SYMBOLS	S2AF	S2BF	S2DF	S2GF	S2JF	S2KF	S2MF	UNITS
Maximum repetitive peak reverse voltage	V_{RRM}	50	100	200	400	600	800	1000	VOLTS
Maximum RMS voltage	V_{RMS}	35	70	140	280	420	560	700	VOLTS
Maximum DC blocking voltage	V_{DC}	50	100	200	400	600	800	1000	VOLTS
Maximum average forward rectified current at $T_L=75^\circ\text{C}$	$I_{(AV)}$	2.0							Amps
Peak forward surge current 8.3ms single half sine-wave superimposed on rated load (JEDEC Method)	I_{FSM}	60.0							Amps
Maximum instantaneous forward voltage at 2.0A	V_F	1.1							Volts
Maximum DC reverse current at rated DC blocking voltage	I_R	5.0 50.0							μA
Typical junction capacitance (NOTE 1)	C_J	30.0							pF
Typical thermal resistance (NOTE 2)	$R_{\theta JA}$	50.0							$^\circ\text{C/W}$
Operating junction and storage temperature range	T_J, T_{STG}	-50 to +150							$^\circ\text{C}$

Note: 1. Measured at 1MHz and applied reverse voltage of 4.0V D.C.
 2. P.C.B. mounted with 0.2x0.2" (5.0x5.0mm) copper pad areas



RATINGS AND CHARACTERISTIC CURVES S2AF THRU S2MF

AVERAGE FORWARD RECTIFIED CURRENT, AMPERES

FIG. 1- FORWARD CURRENT DERATING CURVE

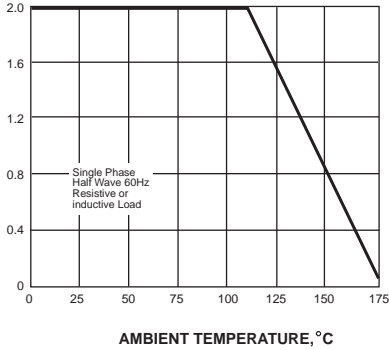

PEAK FORWARD SURGE CURRENT, AMPERES

FIG. 2-MAXIMUM NON-REPETITIVE PEAK FORWARD SURGE CURRENT

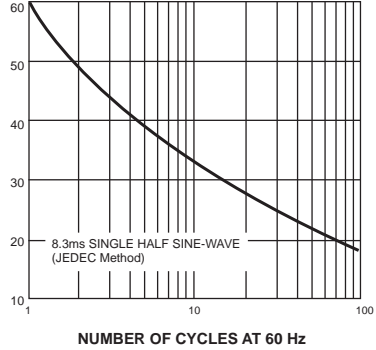

INSTANTANEOUS FORWARD CURRENT, AMPERES

FIG. 3-TYPICAL INSTANTANEOUS FORWARD CHARACTERISTICS

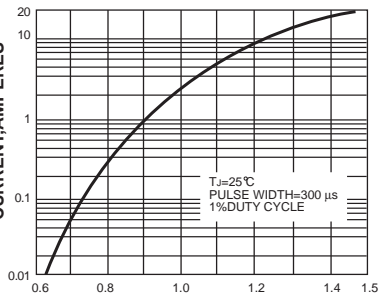

INSTANTANEOUS REVERSE CURRENT, MICROAMPERES

FIG. 4-TYPICAL REVERSE CHARACTERISTICS

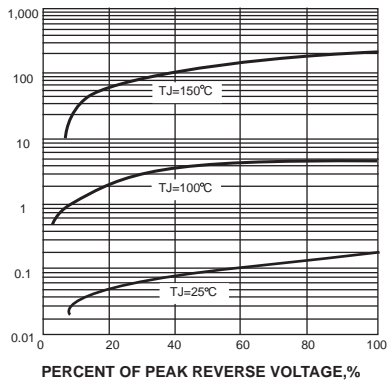

JUNCTION CAPACITANCE, pF

FIG. 5-TYPICAL JUNCTION CAPACITANCE

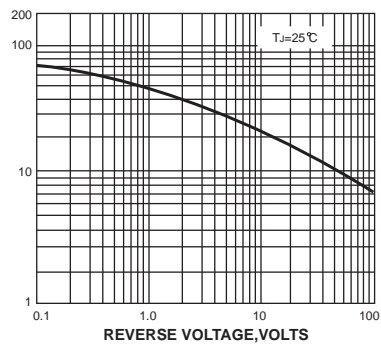

TRANSIENT THERMAL IMPEDANCE, °C/W

FIG. 6-TYPICAL TRANSIENT THERMAL IMPEDANCE

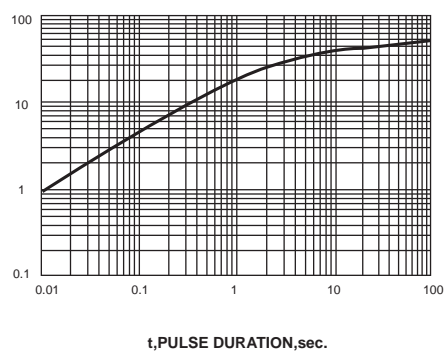

The cruve graph is for reference only, can't be the basis for judgment(曲线图仅供参考)!

